

Honeywell

# WT8840 Trade Water Heater Controls

## INSTALLATION INSTRUCTIONS

### APPLICATION

The WT8840 Water Heater Control is designed for use in Standing Pilot applications using an immersion well for water temperature sensing. All models of WT8840 include an integrated NTC temperature sensor.

The WT8840 is powered from a thermopile heated by the standing pilot flame. CS8840 pilot assemblies are designed for use with this control.

The immersion well for sensing water temperature has matched NTC thermistor sensors. These sensors provide the fail-safe mechanism through which the WT8840 can provide both accurate water temperature control as well as water temperature limit (Temperature Cut-Out [TCO]) function.

Trade Service Part	Replaces
WT8840A1000	WV8840A1000
	WV8840A1001
WT8840A1500	WV8840A1050
	WV8840A1051
WT8840B1000	WV8840B1042
	WV8840B1109
	WV8840B1110
WT8840B1500	WV8840B1059
	WV8840B1117
	WV8840B1118

### SPECIFICATIONS

**IMPORTANT**

*WT8840 controls provide direct replacement only.*

**Pressure Regulator:** The outlet pressure regulator setting is shown on the product label.

**Inlet Pressure Range:**

See appliance rating plate for inlet pressure range recommendation.

0.5 PSI (14.0 in. w.c.) maximum inlet pressure allowed for proper operation.

**Body Pattern:** 90 degrees with 1/2 in. inlet and 1/2 in. inverted flare outlet.

**Mounting:** Mounting in upright position only.

**Control Input:**

Voltage Minimum: 350 mV dc, open circuit.

Voltage Maximum: 850 mV dc, open circuit.

**Capacity:** See Table 1.

**Regulation Range:**

Natural Gas:

Minimum: 30,000 Btuh.

Maximum: 85,000 Btuh.

**Ambient Temperature Range:** 32 to 150 °F (0 to 66 °C)

**Operating Range:** 0 to 150 °F (-18 to 66 °C)\*

\*Valve will operate at 0°F (-18°C) but valve characteristics can not be guaranteed until ambient temperature reaches 32°F (0°C).

**Storage Range:** -40 to 150 °F (-40 to 66 °C)

**Humidity:** 95% non-condensing at 104 °F (40 °C)

**Approvals:**

This device is certified by Canadian Standards Association (CSA) to the following standards:

ANSI Z21.20

ANSI Z21.23

ANSI Z21.78

ANSI Z21.87

CAN/CSA-C22.2 No. 199-M89

CAN1-6.6-M78

CSA 4.6

CSA 6.20

**Accessory Parts:**

Pilot Assembly CS8840



34-00013EF-01

# PLANNING THE INSTALLATION

## **!** WARNING

**Fire or Explosion Hazard.**  
Can cause severe injury, death or property damage.

Follow these warnings exactly:

1. Plan the installation as outlined below
2. Plan for frequent maintenance as described in the Maintenance section.
3. Review the following conditions that can apply to your specific installation and take the precautionary steps provided.

## Frequent Cycling

This control is designed for use on appliances that typically cycle three to five times a day. In year-round applications with greater cycling rates of 10,000 cycles annually, the control can wear out more quickly. Perform a monthly check-out.

## Water or Steam Cleaning

If a control gets submerged in water, replace it. If the appliance is likely to be cleaned with water or steam, protect (cover) the control and wiring from water or steam flow. Mount the control high enough above the bottom of the cabinet so it does not get wet during normal cleaning procedures.

## High Humidity or Dripping Water

Dripping water can cause the control to fail. Never install an appliance where water can drip on the control. In addition, high ambient humidity can cause the control to corrode and fail. If the appliance is in a humid atmosphere, make sure air circulation around the control is adequate to prevent condensation. Also, regularly check out the system.

## Corrosive Chemicals

Corrosive chemicals can attack the control, eventually causing a failure. If chemicals are used for routine cleaning, avoid contact with the control. Where chemicals are suspended in air, as in some industrial or agricultural applications, protect the control with a cover.

## Dust or Grease Accumulation

Heavy accumulations of dust or grease can cause the control to malfunction. Where dust or grease can be a problem, provide covers for the control to limit contamination.

## Heat

Excessively high temperature can damage the control. Make sure the maximum ambient temperature at the control does not exceed the rating of the control. If the appliance operates at very high temperatures, use insulation, shielding, and air circulation, as necessary, to protect the control. Proper insulation or shielding

should be provided by the appliance manufacturer. Verify proper air circulation is maintained when the appliance is installed.

## Flow Capacity & Pressure Drop

Fig. 1 shows the typical flow (kBtu/hr) vs pressure drop (in. w.c.) curve for natural gas and LP gas. Actual pressure drop depends on the internal configuration of the valve. Table 1 shows the pressure drop at various flows for the control.

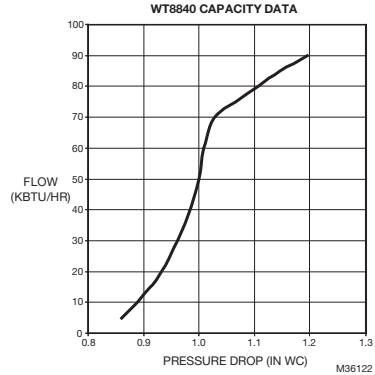

**Fig. 1. Typical capacity curve for WT8840 family water heater control system.**

**Table 1. Gas capacity conversion for WT8840.**

Gas Type	Flow (kBtu/hr)	Pressure Drop (in. w.c.)
NG	30	1.43
	50	1.47
	75	1.54
LP	30	0.91
	50	0.94
	75	0.97

# INSTALLATION

## When Installing This Product...

1. Read these instructions carefully. Failure to follow them could damage the product or cause a hazardous condition.
2. Check the ratings given in the instructions and on the product to make sure the product is suitable for your application.
3. Installer must be a trained, experienced service technician.
4. After installation is complete, check out product operation as provided in these instructions.

## **⚠ WARNING**

**Fire or Explosion Hazard.**  
Can cause severe injury, death or property damage.

Follow these warnings exactly:

1. To avoid dangerous accumulation of fuel gas, turn off gas supply at the appliance service valve before starting installation and perform the Gas Leak Test after completion of installation.
2. Always install a sediment trap in gas supply line to prevent contamination of ignition system control.
3. Follow the appliance manufacturer instructions if available; otherwise, use these instructions as a guide.

## **⚠ WARNING**

**Scalding Hazard.**  
Can cause burns, severe injury or death.  
Always use a direct replacement sensor assembly when replacing a temperature sensor.

## Location

The WT8840 is mounted on the outside of the water heater tank. See Fig. 2.

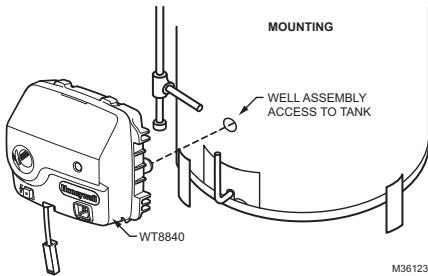

**Fig. 2. Mounting the WT8840 on the water heater tank.**

## Install Control to Water Tank

1. To install the water heater control, screw the assembly into spud until the bracket is square. Use a maximum torque of 31 ft.-lbs. plus one turn.
2. Follow steps in the Connect Gas Supply section.

### IMPORTANT

*These water heater system controls are shipped with protection for the inlet and outlet tappings. Do not remove the protection until you are ready to connect the piping.*

## Connect Gas Supply

All piping must comply with local codes and ordinances or with the National Fuel Gas Code (ANSI Z223.1 NFPA No. 54), whichever applies. Tubing installation must comply with approved standards and practices.

1. Use a new, properly reamed pipe free from chips. If tubing is used, make sure the ends are square, deburred and clean. All tubing bends must be smooth and without deformation.
2. Ensure that gas supply is turned off.
3. Run pipe or tubing to the water heater control. If tubing is used, obtain a tube-to-pipe coupling to connect the tubing to the control.
4. Install a sediment trap in the supply line to the water heater control. See Fig. 3.

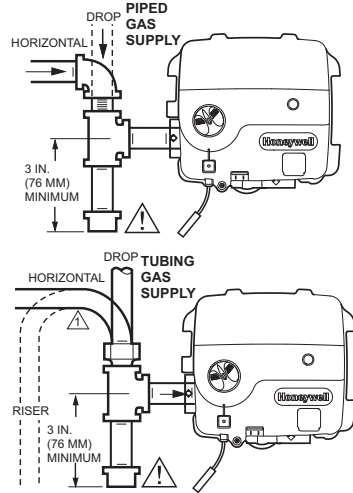

- ⚠ WARNING**  
EXPLOSION HAZARD.  
FAILURE TO FOLLOW PRECAUTIONS CAN RESULT IN A GAS-FILLED WORK AREA.  
SHUT OFF THE MAIN GAS SUPPLY BEFORE REMOVING END CAP.  
TEST FOR GAS LEAKAGE WHEN INSTALLATION IS COMPLETE.
- ⚠ ALL BENDS IN METALLIC TUBING SHOULD BE SMOOTH. M29522

**Fig. 3. Install a sediment trap in the supply line.**

## **⚠ WARNING**

**Explosion Hazard.**  
Can cause severe injury, death or property damage.

Check for gas leaks with soap and water solution any time work is done on a gas system.

5. Apply a moderate amount of good quality pipe compound, leave two end threads bare. Do not use pipe dope on the outlet. See Fig. 4
6. Remove the seals over the water heater control inlet and outlet, if necessary.
7. Connect the pipe to the water heater control inlet and outlet. Use a wrench on the square end of the water heater control. Maximum torque on the inlet is 40 ft.-lbs.; maximum torque on the outlet is 30 ft.-lbs.
8. Position compression fitting in pilot outlet and engage threads. See Fig. 5 for controls and connections. Turn until finger tight, then tighten one more turn with a wrench. Do not overtighten.

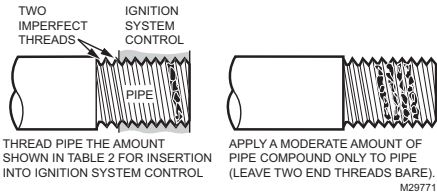

Fig. 4. Use a moderate amount of pipe compound.

Table 2. NPT pipe thread length (in.).

Pipe Size	Thread Pipe This Amount	Maximum Depth Pipe can be inserted into Control
1/2	3/4	1/2

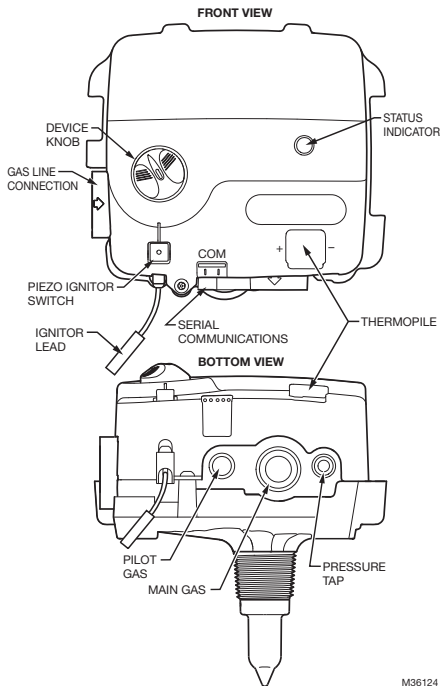

Fig. 5. Water heater controls and connections.



**CAUTION**

**Contamination Hazard.**  
**Can cause equipment malfunction.**  
 Do not use thread tape sealants to seal the gas supply to the control.

- a. Use a pipe dope compound to seal the connection.
- b. Use only ANSI-approved compounds.

**Wiring**

Follow the wiring instructions furnished by the appliance manufacturer, if available, or use the general instructions provided below. When these instructions differ from the appliance manufacturer, follow the appliance manufacturer instructions. Make sure wiring insulation does not get cut by sharp edges.

**NOTE:** All wiring must comply with applicable electrical codes and ordinances.

Connect control circuit to the water heater control using the connections shown in Fig. 5.

**Fill Tank**

Refer to the appliance manufacturer's instructions to fill the tank with water.

**Pilot Gas and Lighting Procedure**

1. Start by turning the device knob to Pilot, push the knob down, and hold in position. (The pilot valve opens and allows gas to flow into the pilot burner.)

**NOTE:** If the gas pipe is full of air (new installation), it takes a long time to purge the air through the pilot before the pilot will light. Approximately 5 minutes of purge time is required for every 10 feet of 1/2-in. pipe with 5 in. w.c. pressure.

2. Depress the piezo igniter to light the pilot flame and hold the knob in until the status indicator starts to blink (approximately 30 seconds), indicating pilot now being held by electronics.

**NOTE:** LED should blink once every three seconds. If not, check the error codes in Table 3.

3. Release the knob and turn to the desired temperature setting. The burner will come on if water temperature is significantly below the temperature setpoint and the LED will begin to strobe every three seconds.
4. Allow one minute for thermopile to cool before re-lighting pilot.

**Turn on Main Burner**

Follow the instructions provided by the manufacturer or turn up the temperature at the setpoint knob.



**WARNING**

**Scalding Hazard.**

**Can cause burns, severe injury or death.**

Never move the setpoint knob past the Hot setting unless extremely hot water is desired. Always check water temperature at the faucet and readjust until comfortably warm to the touch. Consider the ages and health of all who will come in contact with heated water.

## Perform Gas Leak Test



### WARNING

**Fire or Explosion Hazard.**  
Can cause severe injury, death or property damage.

Check for gas leaks with soap and water solution any time work is done on a gas system.



### CAUTION

**Water Damage Hazard.**  
Can damage electrical components in the WT8840.

Do not spray soap and water solution on the WT8840 housing. Do not use an excessive amount of soap and water to perform the gas leak test.

## Gas Leak Test

1. Paint pipe connections upstream of the water heater control with a rich soap and water solution. Bubbles indicate a gas leak.
2. If a leak is detected, tighten the pipe connection.
3. Stand clear of the burner while lighting to prevent injury caused from hidden leaks that could cause flashback in the appliance burner compartment.
4. With the burner in operation, paint the pipe joints (including adapters) and the control inlet and outlet with a rich soap and water solution.
5. If another leak is detected, tighten the adapter screw, joints, and pipe connections.
6. Replace the part(s) if a leak cannot be stopped.

## Check the gas input and burner flow rate



### WARNING

**Fire or Explosion Hazard.**  
Can cause severe injury, death or property damage.

Follow these warnings exactly:

1. Do not exceed input rating stamped on appliance nameplate or manufacturer recommended burner orifice pressure for size of orifice(s) used. Follow instructions of appliance manufacturer.
2. IF CHECKING GAS INPUT BY CLOCKING GAS METER: Make certain there is no gas flow through the meter other than to the appliance being checked. Other appliances must remain off with the pilots extinguished (or that consumption must be deducted from the meter reading). Convert flow rate to Btuh as described in form number 70-2602, Gas Controls Handbook, and compare to Btuh input rating on appliance nameplate.
3. IF CHECKING GAS INPUT WITH MANOMETER: Make sure the manual gas shutoff switch is in the OFF position before removing outlet pressure tap plug to connect the manometer (pressure gauge). Also, move the manual gas shutoff switch to the OFF position when removing the gauge and replacing the plug. Also shut off gas supply before disconnecting manometer and replacing plug. Repeat Gas Leak Test at plug with main burner operating.

## Procedure to check the gas input and burner flow rate

1. Check the full rate manifold pressure listed on the appliance nameplate. Water heater control full rate outlet pressure should match this rating.
2. With burner operating, check the water heater control flow rate using the meter clocking method or check pressure using a manometer connected to the outlet pressure tap on the water heater control. See Fig. 5.

## MAINTENANCE



### WARNING

**Fire or Explosion Hazard. Can cause severe injury, death or property damage.**

Do not attempt to take apart or clean the gas valve inside the WT8840 control. Improper cleaning or reassembly can cause gas leakage.

The maintenance program should include regular checkout of the control as outlined in the Startup and Checkout section, and the control system as described in the appliance manufacturer literature.

Maintenance frequency must be determined individually for each application. Some considerations are:

1. Cycling frequency. Appliances that may cycle 10,000 times annually should be checked monthly.
2. Intermittent use. Appliances that are used seasonally should be checked before shutdown and again before the next use.
3. Consequence of unexpected shutdown. Where the cost of an unexpected shutdown would be high, the system should be checked more often.
4. Dusty, wet or corrosive environment. Since these environments can cause the control to deteriorate more rapidly, the system should be checked more often.

The system should be replaced if:

- It does not perform properly on checkout or troubleshooting.
- The control is likely to have operated for more than 150,000 cycles.
- The control is wet or looks as if it has been wet.

## TROUBLESHOOTING

### Troubleshooting With Status Indicator Assistance

1. Pilot burner must be lit. If not, push and hold Pilot knob and light pilot with piezo. Error code will be displayed when thermopile heats up. Error code can be recognized by counting the number of flashes of the status indicator after a three second pause. One single flash (with set point knob in PILOT position) indicates that the control is in normal operation.
2. Observe status indicator on control; check and repair the system as noted in Table 3 on page 6. Flash codes are displayed with a three-second delay between cycles. A continuous solid light indicates system shutdown when knob is turned from a temperature setting to OFF position.

When the solid light is present, the pilot and main valve will not hold. When the status indicator goes out, the user can restart the system. (Approximate shutdown time is one minute.)

3. After status indicator analysis and appliance repair is complete, turn device knob to OFF, wait until the indicator goes out, then perform lighting procedure.
4. Status indicator light should be in normal mode (1 flash) with the knob in the PILOT position. Turn the device knob past the water temperature in the tank should turn on the main burner. The Status indicator light will strobe every three seconds when there is a call for heat.
5. In the event of multiple failure codes, the next failure code follows the previous failure code by approximately three seconds with higher flash count first.

**Table 3. Troubleshooting with status light visual indication.**

	<b>LED Error Code**</b>	<b>Number of LED Flashes *</b>	<b>Detected Failure</b>	<b>Recommended Action</b>
Normal operation. No action required.	1 flash every 3 seconds	□ □ □ □	Not an error; indicates the electronics is holding the Pilot Valve open and the Main Valve closed.	You can now turn the knob to a desired setpoint temperature. LED will continue to flash 1 time every 3 seconds while in Idle mode (no call for heat).
	Strobe every 3 seconds	□□ □□ □□ □□	Not an error; indicates call for heat during normal operation, Main valve open.	None.
Action required.	2 flashes	□□ □□ □□	Low thermopile voltage; main valve not turned ON.	Check thermopile and its connections. Check pilot flame.
	4 flashes	□□□□ □□□□	Temperature cut-out limit reached.	Check the valves and the water temperature sensor. Reduce the water temperature setpoint. Thoroughly check out main valve operation and water temperature control before walking away.
	5 flashes	□□□□□□	Water temperature sensor failure.	Check water temperature sensor and its connection for open circuits, shorts, or differences in resistance between the two sensor elements.
	6 flashes	□□□□□□□□	Tank leakage detected by accessory module.	Control recovers after receiving message from accessory module.
	7 flashes	□□□□□□□□□□	Electronics Failure	Replace control module.
	8 Flashes	□□□□□□□□□□	This is just a warning; The control does not see power decaying with the knob in the OFF position.	Check valves.
	Solid ON	□□□□□□□□□□	Not an error— indicates that the control is in OFF mode.	None; wait until LED turns off if you want to restart the system.

\* LED Error Codes are flashed once per second, with a three-second pause between repeating the error code.

\*\*Maximum two different errors can be displayed simultaneously if more than one error has been detected.

## Troubleshooting Without Status Indicator Assistance

Follow diagram in Fig. 6.

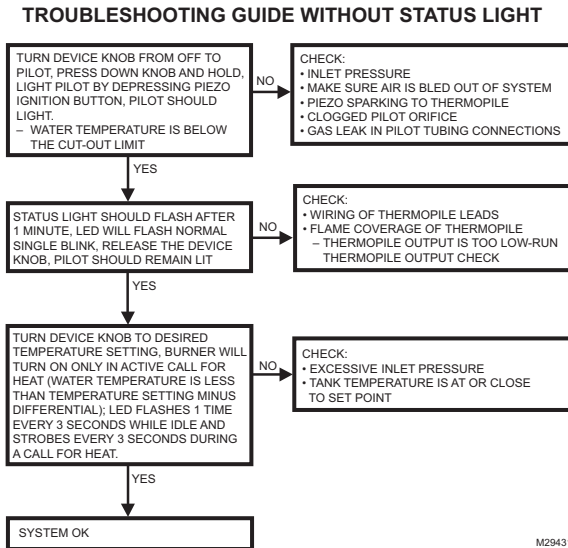

**Fig. 6. Troubleshooting without status light.**

## Thermopile Output Check

1. Turn device knob to OFF.
2. Disconnect thermopile leads.
3. Turn device knob to PILOT, hold down knob to light pilot burner. Hold the knob down for five or more minutes.
4. After five minutes, check thermopile output by connecting the voltmeter to the positive red lead and negative white lead.
5. Output should be at least 350 mV. (See Fig. 7.) Connect the 3.6 ohm resistor between the two thermopile leads, the voltage should be at or higher than one half of the open circuit voltage.
6. The terminal housing prevents miswiring of positive and negative leadwires.
7. Flame must envelop thermopile at Hot Junction (3/8 in. below tip).
8. Keep heat away from cold junction (brass sleeve of the thermopile) for maximum output.

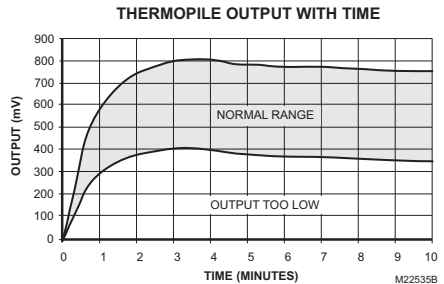

**Fig. 7. Thermopile output.**

## INSTRUCTIONS TO THE HOMEOWNER

### WARNING

#### Fire or Explosion Hazard.

Can cause severe injury, death or property damage.

#### 1. IF YOU SMELL GAS:

- Turn off the gas supply at the appliance service valve.
- Do not light any appliances in the house.
- Do not touch electrical switches or use the phone. Leave the building and use a neighbor's phone to call your gas supplier.
- If you cannot reach your gas supplier, call the fire department.

2. The water heater control must be replaced in event of any physical damage, tampering, bent terminals, missing or broken parts, stripped threads or evidence of exposure to heat.

### WARNING

#### Scalding Hazard.

Can cause burns, severe injury or death.

Never move temperature setpoint knob past the HOT setting without checking water temperature at the faucet, and readjusting until comfortably warm to the touch. Consider the ages and health of all who will come into contact with heated water.

#### IMPORTANT

*Follow the operating instructions provided by the manufacturer of your water tank appliance. The information in this form describes a typical water heater control application, but the specific controls used and the procedures outlined by the manufacturer of your appliance can differ, requiring special instructions.*

## STOP: READ THE WARNINGS ABOVE.

If the appliance does not turn on when the setpoint knob is set several degrees above the previous temperature, follow these instructions:

1. Set the temperature setpoint knob to OFF.
2. Turn off the main gas valve to the appliance.
3. Wait five minutes to clear out any unburned gas. If you then smell gas, STOP! Follow step 1 in the warning above. If you DO NOT smell gas, continue with the next step.
4. Turn on the gas supply to the appliance.
5. Restart the appliance by performing lighting procedure.
6. Set the setpoint knob to the desired setting.
7. If the appliance does not turn on, turn off the gas supply to the appliance and contact a qualified service technician for assistance.
8. Allow one minute for thermopile to cool before re-lighting pilot.

## TURNING OFF THE APPLIANCE

### Complete Shutdown

1. Turn device knob to OFF. Turn off the gas supply to the appliance. Appliance will completely shut off.
2. Follow the procedure in the Instructions to the Homeowner section above to resume normal operation.

#### Automation and Control Solutions

Honeywell International Inc.  
1985 Douglas Drive North  
Golden Valley, MN 55422  
customer.honeywell.com

# Honeywell